



# ULTRAHEAT

## Compact 4 & 6

Panel Radiators Pricelist

JULY 2024 GBP

**Durable and versatile, Compact 4 and Compact 6 radiators offer a range of cost-effective, rapid heating solutions for homes and working environments.**

### 10-YEAR WARRANTY

Each radiator is individually tested and supplied complete with a 10-year warranty against any defects as a result of a manufacturing or a material fault.

All radiators are pressure tested at 13 Bars before despatch to guarantee a working pressure of 10 Bars.

### MATERIAL

Products are manufactured from 1.2mm cold rolled steel.

### INSTALLATION

Each radiator is supplied with concealed brackets, 1/2 self-jointing air vents and plugs in protective, heavy duty packaging.

### QUALITY

All radiators are manufactured under BS EN ISO 9001:2015.



## COMPACT 4 SF

### Single Panel, Single Convactor

#### IN-STOCK RANGE: COLOUR CODING

 Standard Compact 4 (While stocks last)  
200mm and 300mm vertical radiators with waterways that run horizontally. (tappings of the normal Compact 4 radiators turned 90° to the side).

 Standard Compact 4 Radiators with 4 taps.

#### FACTORY ORDER

 Compact 4 & 6  
Non-stock items.  
Factory order only.

SF

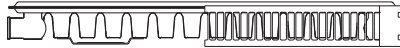

ALL PRICES EX. VAT

Width		SF	Height 300mm (11.8")			SF	Height 400mm (15.7")			SF	Height 500mm (19.7")			SF	Height 600mm (23.6")		
mm	inch	Code H+Type+W	Output ΔT50°C BTU	Watts	Price £/Each	Code H+Type+W	Output ΔT50°C BTU	Watts	Price £/Each	Code H+Type+W	Output ΔT50°C BTU	Watts	Price £/Each	Code H+Type+W	Output ΔT50°C BTU	Watts	Price £/Each
v200	7.9	-	-	-	-	-	-	-	-	5vSF200	515	151	£139.97	-	-	-	-
300	11.8	-	-	-	-	-	-	-	-	5SF300	858	251	£174.09	6SF300	993	291	£182.51
400	15.7	3SF400	739	216	£105.52	4SF400	952	279	£113.75	5SF400	1145	335	£132.15	6SF400	1325	388	£152.66
500	19.7	3SF500	924	271	£117.94	4SF500	1190	349	£129.53	5SF500	1431	419	£151.67	6SF500	1657	485	£165.56
600	23.6	3SF600	1109	325	£126.12	4SF600	1429	418	£151.18	5SF600	1718	503	£172.90	6SF600	1988	582	£181.61
700	27.6	3SF700	1294	379	£148.08	4SF700	1667	488	£172.90	5SF700	2004	587	£200.04	6SF700	2319	679	£211.39
800	31.5	3SF800	1478	433	£170.12	4SF800	1905	558	£197.41	5SF800	2290	670	£229.76	6SF800	2651	776	£241.13
900	35.4	3SF900	1663	487	£189.17	4SF900	2143	627	£226.93	5SF900	2576	754	£256.71	6SF900	2982	873	£270.94
1000	39.4	3SF1000	1848	541	£213.11	4SF1000	2378	697	£248.65	5SF1000	2859	838	£280.97	6SF1000	3310	970	£300.72
1100	43.3	3SF1100	2033	595	£233.88	4SF1100	2619	767	£273.06	5SF1100	3149	922	£307.76	6SF1100	3645	1067	£330.61
1200	47.2	3SF1200	2218	649	£258.34	4SF1200	2857	836	£297.44	5SF1200	3435	1006	£335.01	6SF1200	3976	1164	£360.51
1300	51.2	3SF1300	2402	703	£278.59	4SF1300	3095	906	£321.75	5SF1300	3721	1089	£362.10	6SF1300	4308	1261	£421.52
1400	55.1	3SF1400	2587	757	£301.63	4SF1400	3333	976	£346.01	5SF1400	4008	1173	£389.11	6SF1400	4639	1358	£429.91
1500	59.1	-	-	-	-	4SF1500	3567	1046	£375.40	5SF1500	4289	1257	£430.55	6SF1500	4964	1455	£459.05
1600	63	3SF1600	2957	866	£350.11	4SF1600	3810	1115	£394.56	5SF1600	4580	1341	£446.02	6SF1600	5302	1552	£482.25
1800	70.9	3SF1800	3327	974	£396.25	4SF1800	4286	1255	£443.10	5SF1800	5153	1508	£502.66	6SF1800	5964	1746	£583.54
2000	78.7	3SF2000	3696	1082	£464.05	4SF2000	4762	1394	£485.70	5SF2000	5725	1676	£562.15	6SF2000	6627	1940	£654.21
2200	86.6	3SF2200	4066	1190	£525.78	4SF2200	5238	1533	£563.71	5SF2200	6298	1844	£646.23	6SF2200	7290	2134	£753.00
2400	94.5	3SF2400	4435	1298	£590.36	4SF2400	5714	1673	£647.13	5SF2400	6870	2011	£732.96	6SF2400	7952	2328	£847.98
2700	106.3	3SF2700	4990	1461	£703.81	4SF2700	6429	1882	£750.41	5SF2700	7729	2263	£869.88	6SF2700	8947	2619	£999.44
3000	118.1	3SF3000	5544	1623	£815.33	4SF3000	7143	2091	£842.34	5SF3000	8588	2514	£985.54	6SF3000	9941	2910	£1,124.57

Width		SF	Height 700mm (27.6")			SF	Height 900mm (35.4")			SF	Height 1800mm (70.86")			SF	Height 2000mm (78.74")		
mm	inch	Code H+Type+W	Output ΔT50°C BTU	Watts	Price £/Each	Code H+Type+W	Output ΔT50°C BTU	Watts	Price £/Each	Code H+Type+W	Output ΔT50°C BTU	Watts	Price £/Each	Code H+Type+W	Output ΔT50°C BTU	Watts	Price £/Each
v200	7.9	7vSF200	671	197	£202.37	9vSF200	805	236	£269.85	-	-	-	-	-	-	-	-
400	15.7	7SF400	1493	437	£194.45	9SF400	1791	524	£254.88	18VSF400	3583	1049	£754.38	20VSF400	3981	1165	£805.10
500	19.7	7SF500	1867	547	£203.29	9SF500	2239	656	£262.63	18VSF500	4478	1311	£808.02	20VSF500	4976	1457	£855.56
600	23.6	7SF600	2240	656	£243.63	9SF600	2687	787	£310.23	18VSF600	5374	1573	£864.70	20VSF600	5971	1748	£913.76
700	27.6	7SF700	2614	765	£282.90	9SF700	3135	918	£360.68	-	-	-	-	-	-	-	-
800	31.5	7SF800	2987	874	£325.20	9SF800	3583	1049	£410.97	-	-	-	-	-	-	-	-
900	35.4	7SF900	3360	984	£365.35	9SF900	4031	1180	£463.95	-	-	-	-	-	-	-	-
1000	39.4	7SF1000	3729	1093	£399.09	9SF1000	4473	1311	£514.46	-	-	-	-	-	-	-	-
1100	43.3	7SF1100	4107	1202	£439.17	9SF1100	4926	1442	£567.54	-	-	-	-	-	-	-	-
1200	47.2	7SF1200	4480	1312	£479.28	9SF1200	5374	1573	£620.57	-	-	-	-	-	-	-	-
1300	51.2	7SF1300	4854	1421	£519.22	-	-	-	-	-	-	-	-	-	-	-	-
1400	55.1	7SF1400	5227	1530	£559.13	9SF1400	6270	1835	£721.23	-	-	-	-	-	-	-	-
1500	59.1	7SF1500	5594	1640	£598.96	-	-	-	-	-	-	-	-	-	-	-	-
1600	63	7SF1600	5974	1749	£638.80	-	-	-	-	-	-	-	-	-	-	-	-
1800	70.9	7SF1800	6721	1967	£718.44	-	-	-	-	-	-	-	-	-	-	-	-
2000	78.7	7SF2000	7467	2186	£806.30	-	-	-	-	-	-	-	-	-	-	-	-
2200	86.6	7SF2200	8214	2405	£912.81	-	-	-	-	-	-	-	-	-	-	-	-
2400	94.5	7SF2400	8961	2623	£1,080.66	-	-	-	-	-	-	-	-	-	-	-	-

## White RAL 9016 and Anthracite RAL 7016

Compact 4 radiators are supplied in White RAL 9016 with an option for factory-baked Anthracite RAL 7016 grey in the models and sizes shown right.

Width		Finish	SF-A	Height 600mm (23.6")		
mm	inch	RAL Colour	Code H+Type+W	Output ΔT50°C BTU	Watts	Price £/Each
600	23.6	Anthracite RAL 7016	6SF600A	1988	582	£272.40
800	31.5	Anthracite RAL 7016	6SF800A	2651	776	£354.47
1000	39.4	Anthracite RAL 7016	6SF1000A	3310	970	£436.05
1200	47.2	Anthracite RAL 7016	6SF1200A	3976	1164	£519.14
1400	55.1	Anthracite RAL 7016	6SF1400A	4639	1358	£614.78
1600	63	Anthracite RAL 7016	6SF1600A	5302	1552	£684.79

**IN-STOCK RANGE: COLOUR CODING**

 Standard Compact 4 (While stocks last) 200mm and 300mm vertical radiators with waterways that run horizontally. (tappings of the normal Compact 4 radiators turned 90° to the side).

 Standard Compact 4 Radiators with 4 taps.

**FACTORY ORDER**

 Compact 4 & 6 Non-stock items. Factory order only.

**COMPACT 4 HF**  
Double Panel, Single Convecter

HF

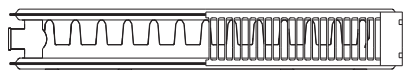

ALL PRICES EX. VAT

Width		HF	Height 300mm (11.8")			HF	Height 400mm (15.7")			HF	Height 500mm (19.7")			HF	Height 600mm (23.6")		
mm	inch	Code	Output ΔT50°C		Price	Code	Output ΔT50°C		Price	Code	Output ΔT50°C		Price	Code	Output ΔT50°C		Price
		H+Type+W	BTU	Watts	£/Each	H+Type+W	BTU	Watts	£/Each	H+Type+W	BTU	Watts	£/Each	H+Type+W	BTU	Watts	£/Each
300	11.8	-	-	-	-	-	-	-	-	-	-	-	-	-	-	-	-
400	15.7	3HF400	1120	328	£175.14	4HF400	1428	418	£181.25	5HF400	1718	503	£199.05	6HF400	1493	437	£264.19
500	19.7	3HF500	1401	410	£199.02	4HF500	1785	523	£203.97	5HF500	2147	629	£223.13	6HF500	2489	729	£256.39
600	23.6	3HF600	1681	492	£245.19	4HF600	2142	627	£237.00	5HF600	2576	754	£267.60	6HF600	2986	874	£299.22
700	27.6	3HF700	1961	574	£277.08	4HF700	2499	732	£274.36	5HF700	3006	880	£312.31	6HF700	3484	1020	£349.63
800	31.5	3HF800	2241	656	£311.38	4HF800	2856	836	£311.92	5HF800	3435	1006	£354.84	6HF800	3982	1166	£400.22
900	35.4	3HF900	2521	738	£347.40	4HF900	3213	941	£349.25	5HF900	3865	1131	£399.43	6HF900	4479	1311	£448.82
1000	39.4	3HF1000	2801	820	£389.22	4HF1000	3570	1045	£387.14	5HF1000	4294	1257	£444.14	6HF1000	4977	1457	£501.20
1100	43.3	3HF1100	3081	902	£428.10	4HF1100	3927	1150	£424.00	5HF1100	4723	1383	£489.29	6HF1100	5475	1603	£550.76
1200	47.2	3HF1200	3361	984	£471.26	4HF1200	4284	1254	£461.49	5HF1200	5153	1508	£536.95	6HF1200	5973	1748	£600.33
1300	51.2	-	-	-	-	4HF1300	4641	1359	£501.00	5HF1300	5582	1634	£591.42	6HF1300	6470	1894	£700.85
1400	55.1	3HF1400	3922	1148	£554.78	4HF1400	4998	1463	£540.44	5HF1400	6011	1760	£645.86	6HF1400	6968	2040	£710.27
1500	59.1	-	-	-	-	4HF1500	5355	1568	£589.86	5HF1500	6441	1886	£692.31	6HF1500	7466	2186	£808.62
1600	63	3HF1600	4482	1312	£639.75	4HF1600	5712	1672	£611.14	5HF1600	6870	2011	£738.80	6HF1600	7963	2331	£861.97
1800	70.9	3HF1800	5042	1476	£726.13	4HF1800	6425	1881	£690.07	5HF1800	7729	2263	£830.42	6HF1800	8959	2623	£970.77
2000	78.7	-	-	-	-	4HF2000	7139	2090	£790.09	5HF2000	8588	2514	£966.47	6HF2000	9954	2914	£1,162.62
2200	86.6	-	-	-	-	4HF2200	7853	2299	£906.55	5HF2200	9447	2765	£1,095.15	6HF2200	10950	3205	£1,328.00
2400	94.5	-	-	-	-	4HF2400	8567	2508	£1,146.77	5HF2400	10305	3017	£1,326.03	6HF2400	11945	3497	£1,531.03

Width		HF	Height 700mm (27.6")			HF	Height 900mm (35.4")			HF	Height 1800mm (70.86")			HF	Height 2000mm (78.74")		
mm	inch	Code	Output ΔT50°C		Price	Code	Output ΔT50°C		Price	Code	Output ΔT50°C		Price	Code	Output ΔT50°C		Price
		H+Type+W	BTU	Watts	£/Each	H+Type+W	BTU	Watts	£/Each	H+Type+W	BTU	Watts	£/Each	H+Type+W	BTU	Watts	£/Each
400	15.7	7HF400	2250	659	£295.37	9HF400	2730	800	£435.21	18VHF400	5459	1600	£1,033.53	20VHF400	6066	1778	£1,122.04
500	19.7	7HF500	2813	824	£356.72	9HF500	3412	1000	£482.97	18VHF500	6824	2000	£1,088.69	20VHF500	7582	2222	£1,190.96
600	23.6	7HF600	3376	988	£428.04	9HF600	4091	1199	£579.29	18VHF600	8182	2398	£1,181.58	20VHF600	9091	2664	£1,281.85
700	27.6	7HF700	3938	1153	£499.35	9HF700	4773	1399	£676.27	-	-	-	-	-	-	-	-
800	31.5	7HF800	4501	1318	£571.00	9HF800	5459	1600	£937.76	-	-	-	-	-	-	-	-
900	35.4	7HF900	5064	1482	£641.77	-	-	-	-	-	-	-	-	-	-	-	-
1000	39.4	7HF1000	5626	1647	£727.53	-	-	-	-	-	-	-	-	-	-	-	-
1100	43.3	7HF1100	6189	1812	£784.42	-	-	-	-	-	-	-	-	-	-	-	-
1200	47.2	7HF1200	6751	1976	£855.51	-	-	-	-	-	-	-	-	-	-	-	-
1300	51.2	7HF1300	7314	2141	£964.25	-	-	-	-	-	-	-	-	-	-	-	-
1400	55.1	7HF1400	7877	2306	£1,098.62	-	-	-	-	-	-	-	-	-	-	-	-
1500	59.1	-	-	-	-	-	-	-	-	-	-	-	-	-	-	-	-
1600	63	7HF1600	9002	2635	£1,232.68	-	-	-	-	-	-	-	-	-	-	-	-
1800	70.9	7HF1800	10127	2965	£1,425.29	-	-	-	-	-	-	-	-	-	-	-	-

**White RAL 9016 and Anthracite RAL 7016**

Compact 4 radiators are supplied in White RAL 9016 with an option for factory-baked Anthracite RAL 7016 grey in the models and sizes shown right.

Width		Finish	HF-A	Height 600mm (23.6")		
mm	inch	RAL Colour	Code	Output ΔT50°C		Price
			H+Type+W	BTU	Watts	£/Each
600	23.6	Anthracite RAL 7016	6HF600A	2986	874	£418.91
800	31.5	Anthracite RAL 7016	6HF800A	3982	1166	£556.31
1000	39.4	Anthracite RAL 7016	6HF1000A	4977	1457	£686.65
1200	47.2	Anthracite RAL 7016	6HF1200A	5973	1748	£816.44
1400	55.1	Anthracite RAL 7016	6HF1400A	6968	2040	£958.86
1600	63	Anthracite RAL 7016	6HF1600A	7963	2331	£1,172.28

# COMPACT 4 DF

## Double Panel, Double Convector

### IN-STOCK RANGE: COLOUR CODING

 Standard Compact 4 (While stocks last) 200mm and 300mm vertical radiators with waterways that run horizontally. (tappings of the normal Compact 4 radiators turned 90° to the side).

 Standard Compact 4 Radiators with 4 taps.

### FACTORY ORDER

 Compact 4 & 6 Non-stock items. Factory order only.

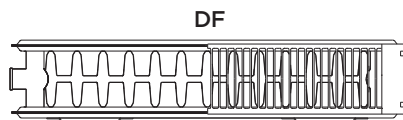

ALL PRICES EX. VAT

Width		DF	Height 300mm (11.8")			DF	Height 400mm (15.7")			DF	Height 500mm (19.7")			DF	Height 600mm (23.6")		
mm	inch	Code H+Type+W	Output BTU	ΔT50°C Watts	Price £/Each	Code H+Type+W	Output BTU	ΔT50°C Watts	Price £/Each	Code H+Type+W	Output BTU	ΔT50°C Watts	Price £/Each	Code H+Type+W	Output BTU	ΔT50°C Watts	Price £/Each
v200	7.9	-	-	-	-	-	-	-	-	5vDF200	995	291	£275.57	6vDF200	1149	336	£323.47
v300	11.8	-	-	-	-	-	-	-	-	5vDF300	1493	437	£278.09	6vDF300	1724	505	£325.97
300	11.8	-	-	-	-	-	-	-	-	5DF300	1659	486	£318.74	6DF300	1915	561	£346.45
400	15.7	3DF400	1437	421	£200.26	4DF400	1841	539	£221.45	5DF400	2212	648	£239.32	6DF400	2554	748	£277.81
500	19.7	3DF500	1797	526	£209.61	4DF500	2301	674	£239.01	5DF500	2765	810	£273.94	6DF500	3192	935	£318.08
600	23.6	3DF600	2156	631	£239.84	4DF600	2761	808	£283.77	5DF600	3318	971	£328.52	6DF600	3831	1121	£353.27
700	27.6	3DF700	2516	736	£280.31	4DF700	3221	943	£328.54	5DF700	3871	1133	£383.32	6DF700	4469	1308	£412.04
800	31.5	3DF800	2875	842	£320.58	4DF800	3681	1078	£373.49	5DF800	4424	1295	£435.52	6DF800	5108	1495	£471.60
900	35.4	3DF900	3234	947	£358.61	4DF900	4141	1212	£418.17	5DF900	4977	1457	£490.38	6DF900	5746	1682	£528.92
1000	39.4	3DF1000	3594	1052	£402.72	4DF1000	4601	1347	£463.01	5DF1000	5531	1619	£545.19	6DF1000	6385	1869	£590.63
1100	43.3	3DF1100	3953	1157	£443.60	4DF1100	5061	1482	£507.77	5DF1100	6084	1781	£598.76	6DF1100	7023	2056	£649.07
1200	47.2	3DF1200	4312	1262	£489.08	4DF1200	5522	1616	£552.66	5DF1200	6637	1943	£652.22	6DF1200	7661	2243	£707.42
1300	51.2	-	-	-	-	4DF1300	5982	1751	£599.94	5DF1300	7190	2105	£706.95	6DF1300	8300	2430	£825.90
1400	55.1	3DF1400	5031	1473	£576.68	4DF1400	6442	1886	£647.13	5DF1400	7743	2267	£761.62	6DF1400	8938	2617	£851.99
1500	59.1	-	-	-	-	4DF1500	6902	2021	£699.66	5DF1500	8296	2429	£826.57	6DF1500	9577	2804	£971.25
1600	63	3DF1600	5750	1683	£663.35	4DF1600	7362	2155	£731.82	5DF1600	8849	2590	£871.29	6DF1600	10215	2990	£1,046.29
1800	70.9	3DF1800	6469	1894	£754.02	4DF1800	8282	2425	£826.36	5DF1800	9955	2914	£980.70	6DF1800	11492	3364	£1,178.30
2000	78.7	3DF2000	7187	2104	£882.53	4DF2000	9203	2694	£920.02	5DF2000	11061	3238	£1,100.74	6DF2000	12769	3738	£1,284.65
2200	86.6	3DF2200	7906	2314	£997.20	4DF2200	10123	2963	£1,047.76	5DF2200	12167	3562	£1,258.82	6DF2200	14046	4112	£1,480.87
2400	94.5	3DF2400	8625	2525	£1,123.23	4DF2400	11043	3233	£1,186.72	5DF2400	13273	3886	£1,419.69	6DF2400	15323	4486	£1,690.98
2700	106.3	3DF2700	9703	2840	£1,314.88	4DF2700	12424	3637	£1,381.56	5DF2700	14932	4371	£1,729.15	6DF2700	17238	5046	£2,029.86
3000	118.1	3DF3000	10781	3156	£1,461.07	4DF3000	13804	4041	£1,565.98	5DF3000	16592	4857	£1,867.76	6DF3000	19154	5607	£2,284.41

Width		DF	Height 700mm (27.6")			DF	Height 900mm (35.4")			DF	Height 1800mm (70.86")			DF	Height 2000mm (78.74")		
mm	inch	Code H+Type+W	Output BTU	ΔT50°C Watts	Price £/Each	Code H+Type+W	Output BTU	ΔT50°C Watts	Price £/Each	Code H+Type+W	Output BTU	ΔT50°C Watts	Price £/Each	Code H+Type+W	Output BTU	ΔT50°C Watts	Price £/Each
v200	7.9	7vDF200	1291	378	£386.70	9vDF200	1542	451	£518.48	-	-	-	-	-	-	-	-
400	15.7	7DF400	2869	840	£335.99	9DF400	3426	1003	£469.35	18vDF400	6851	2006	£1,190.44	20vDF400	7612	2228	£1,259.10
500	19.7	7DF500	3587	1050	£397.58	9DF500	4282	1254	£537.26	18vDF500	8564	2507	£1,257.25	20vDF500	9515	2786	£1,374.60
600	23.6	7DF600	4304	1260	£476.68	9DF600	5138	1504	£644.70	18vDF600	10277	3008	£1,416.93	20vDF600	11419	3343	£1,536.53
700	27.6	7DF700	5022	1470	£556.02	9DF700	5995	1755	£752.23	-	-	-	-	-	-	-	-
800	31.5	7DF800	5739	1680	£635.40	9DF800	6851	2006	£857.23	-	-	-	-	-	-	-	-
900	35.4	7DF900	6456	1890	£715.22	9DF900	7708	2256	£967.24	-	-	-	-	-	-	-	-
1000	39.4	7DF1000	7174	2100	£780.18	9DF1000	8564	2507	£1,069.62	-	-	-	-	-	-	-	-
1100	43.3	7DF1100	7891	2310	£858.39	9DF1100	9420	2758	£1,194.09	-	-	-	-	-	-	-	-
1200	47.2	7DF1200	8608	2520	£936.57	9DF1200	10277	3008	£1,318.78	-	-	-	-	-	-	-	-
1300	51.2	7DF1300	9326	2730	£1,014.39	9DF1300	11133	3259	£1,409.89	-	-	-	-	-	-	-	-
1400	55.1	7DF1400	10043	2940	£1,092.18	9DF1400	11989	3510	£1,501.85	-	-	-	-	-	-	-	-
1500	59.1	7DF1500	10760	3150	£1,171.08	-	-	-	-	-	-	-	-	-	-	-	-
1600	63	7DF1600	11478	3360	£1,249.98	-	-	-	-	-	-	-	-	-	-	-	-
1800	70.9	7DF1800	12912	3780	£1,404.24	-	-	-	-	-	-	-	-	-	-	-	-
2000	78.7	7DF2000	14347	4200	£1,575.52	-	-	-	-	-	-	-	-	-	-	-	-
2200	86.6	7DF2200	15782	4620	£1,784.35	-	-	-	-	-	-	-	-	-	-	-	-
2400	94.5	7DF2400	17217	5040	£2,111.49	-	-	-	-	-	-	-	-	-	-	-	-
2700	106.3	7DF2700	19369	5670	£2,462.08	-	-	-	-	-	-	-	-	-	-	-	-
3000	118.1	7DF3000	21521	6300	£2,787.49	-	-	-	-	-	-	-	-	-	-	-	-

## White RAL 9016 and Anthracite RAL 7016

Compact 4 radiators are supplied in White RAL 9016 with an option for factory-baked Anthracite RAL 7016 grey in the models and sizes shown right.

Width		Finish	DF-A	Height 600mm (23.6")		
mm	inch	RAL Colour	Code H+Type+W	Output BTU	ΔT50°C Watts	Price £/Each
600	23.6	Anthracite RAL 7016	6DF600A	3831	1121	£459.25
800	31.5	Anthracite RAL 7016	6DF800A	5108	1495	£608.36
1000	39.4	Anthracite RAL 7016	6DF1000A	6385	1869	£750.09
1200	47.2	Anthracite RAL 7016	6DF1200A	7661	2243	£891.34
1400	55.1	Anthracite RAL 7016	6DF1400A	8938	2617	£1,064.98
1600	63	Anthracite RAL 7016	6DF1600A	10215	2990	£1,297.40



**IN-STOCK RANGE: COLOUR CODING**

**Compact 6 radiators**  
DS, TS and QS radiators come with 6 taps, including the twin tap of 50mm centre-to-centre on the bottom left corner.

**FACTORY ORDER**

**Compact 4 & 6**  
Non-stock items.  
Factory order only.

**COMPACT 6 DS / TS / QS**  
Double Panel, Double Convactor  
Triple Panel, Triple Convactor  
Quadruple Panel, Quadruple Convactor

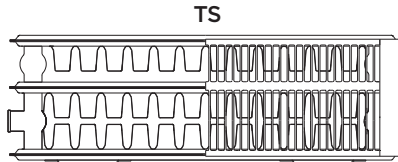
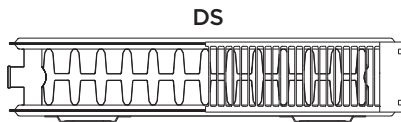

ALL PRICES EX. VAT

Width		DS				TS				TS				TS			
		Code	Output ΔT50°C		Price	Code	Output ΔT50°C		Price	Code	Output ΔT50°C		Price	Code	Output ΔT50°C		Price
mm	inch	H+Type+W	BTU	Watts	£/Each	H+Type+W	BTU	Watts	£/Each	H+Type+W	BTU	Watts	£/Each	H+Type+W	BTU	Watts	£/Each
500	19.7	-	-	-	-	-	-	-	-	3TS500	2482	727	£317.21	4TS500	3182	932	£450.85
600	23.6	-	-	-	-	-	-	-	-	3TS600	2978	872	£372.77	4TS600	3818	1118	£540.41
700	27.6	-	-	-	-	-	-	-	-	3TS700	3474	1017	£408.67	4TS700	4455	1304	£595.33
800	31.5	2DS800	2003	586	£325.59	2TS800	2730	799	£562.22	-	-	-	-	4TS800	5091	1490	£680.74
900	35.4	2DS900	2254	660	£365.47	2TS900	3071	899	£649.41	3TS900	4467	1308	£513.56	4TS900	5728	1677	£766.11
1000	39.4	2DS1000	2504	733	£406.07	2TS1000	3413	999	£708.79	3TS1000	4963	1453	£575.15	4TS1000	6364	1863	£850.76
1100	43.3	-	-	-	-	-	-	-	-	3TS1100	5460	1598	£632.78	4TS1100	7000	2049	£945.02
1200	47.2	2DS1200	3005	880	£488.52	2TS1200	4095	1199	£858.66	3TS1200	5956	1744	£696.90	4TS1200	7637	2236	£1,031.21
1400	55.1	2DS1400	3505	1026	£697.25	2TS1400	4778	1399	£1,011.04	3TS1400	6949	2034	£820.38	-	-	-	-
1600	63	2DS1600	4006	1173	£730.91	2TS1600	5460	1598	£1,165.39	3TS1600	7942	2325	£945.99	4TS1600	10182	2981	£1,400.85
1800	70.9	2DS1800	4507	1319	£910.22	2TS1800	6143	1798	£1,335.18	3TS1800	8934	2615	£1,074.26	4TS1800	11455	3353	£1,590.30
2000	78.7	2DS2000	5008	1466	£1,031.06	2TS2000	6825	1998	£1,723.66	3TS2000	9927	2906	£1,259.96	4TS2000	12728	3726	£1,906.46
2200	86.6	-	-	-	-	-	-	-	-	-	-	-	-	4TS2200	14001	4099	£2,234.41
2400	94.5	2DS2400	6009	1759	£1,331.60	-	-	-	-	-	-	-	-	-	-	-	-
3000	118.1	2DS3000	7512	2199	£1,724.04	-	-	-	-	-	-	-	-	-	-	-	-

Width		TS				TS				TS				TS			
		Code	Output ΔT50°C		Price	Code	Output ΔT50°C		Price	Code	Output ΔT50°C		Price	Code	Output ΔT50°C		Price
mm	inch	H+Type+W	BTU	Watts	£/Each	H+Type+W	BTU	Watts	£/Each	H+Type+W	BTU	Watts	£/Each	H+Type+W	BTU	Watts	£/Each
400	15.7	-	-	-	-	6TS400	3531	1034	£640.63	7TS400	3961	1160	£788.75	9TS400	4711	1379	£922.98
500	19.7	5TS500	3824	1120	£550.48	6TS500	4413	1292	£663.53	7TS500	4951	1450	£819.37	9TS500	5889	1724	£1,066.33
600	23.6	5TS600	4589	1343	£661.16	6TS600	5296	1550	£796.52	7TS600	5942	1739	£974.72	9TS600	7067	2069	£1,278.94
700	27.6	5TS700	5354	1567	£728.95	6TS700	6179	1809	£877.26	7TS700	6932	2029	£1,068.48	9TS700	8245	2414	£1,492.55
800	31.5	5TS800	6119	1791	£832.37	6TS800	7062	2067	£1,002.83	7TS800	7922	2319	£1,216.18	9TS800	9423	2758	£1,706.05
900	35.4	5TS900	6884	2015	£937.41	6TS900	7944	2326	£1,127.68	7TS900	8913	2609	£1,317.98	9TS900	10601	3103	£1,919.17
1000	39.4	5TS1000	7648	2239	£1,040.82	6TS1000	8827	2584	£1,253.21	7TS1000	9903	2899	£1,508.38	9TS1000	11778	3448	£2,132.23
1100	43.3	5TS1100	8413	2463	£1,145.75	6TS1100	9710	2842	£1,378.39	7TS1100	10893	3189	£1,653.90	-	-	-	-
1200	47.2	5TS1200	9178	2687	£1,250.54	6TS1200	10592	3101	£1,503.58	7TS1200	11884	3479	£1,799.40	-	-	-	-
1300	51.2	5TS1300	9943	2911	£1,354.01	-	-	-	-	-	-	-	-	-	-	-	-
1400	55.1	5TS1400	10708	3135	£1,457.39	6TS1400	12358	3618	£1,755.12	7TS1400	13864	4059	£2,137.20	-	-	-	-
1600	63	-	-	-	-	6TS1600	14123	4134	£2,005.53	7TS1600	15845	4638	£2,431.46	-	-	-	-
1800	70.9	5TS1800	13767	4030	£1,873.46	6TS1800	15888	4651	£2,256.59	-	-	-	-	-	-	-	-
2000	78.7	5TS2000	15297	4478	£2,226.03	6TS2000	17654	5168	£2,673.73	-	-	-	-	-	-	-	-
2200	86.6	5TS2200	16827	4926	£2,495.04	-	-	-	-	-	-	-	-	-	-	-	-

Width		QS				QS			
		Code	Output ΔT50°C		Price	Code	Output ΔT50°C		Price
mm	inch	H+Type+W	BTU	Watts	£/Each	H+Type+W	BTU	Watts	£/Each
800	31.5	2QS800	3640	1066	£982.81	3QS800	5294	1550	£1,011.71
900	35.4	2QS900	4095	1199	£1,083.49	3QS900	5956	1743	£1,115.37
1000	39.4	2QS1000	4550	1332	£1,186.85	3QS1000	6618	1937	£1,221.75
1100	43.3	2QS1100	5005	1465	£1,287.88	3QS1100	7280	2131	£1,325.74
1200	47.2	2QS1200	5460	1598	£1,391.21	3QS1200	7942	2324	£1,432.13
1300	51.2	2QS1300	5915	1732	£1,522.48	3QS1300	8603	2518	£1,567.26
1400	55.1	2QS1400	6370	1865	£1,639.74	3QS1400	9265	2712	£1,690.00
1600	63	2QS1600	7280	2131	£1,849.31	3QS1600	10589	3099	£1,905.34
1800	70.9	2QS1800	8190	2398	£2,057.29	3QS1800	11912	3487	£2,119.63
2000	78.7	2QS2000	9100	2664	£2,337.80	3QS2000	13256	3874	£2,323.71
2200	86.6	2QS2200	10010	2930	£2,551.57	3QS2200	14560	4261	£2,631.29
2400	94.5	2QS2400	10920	3197	£2,861.92	3QS2400	15883	4649	£2,954.24

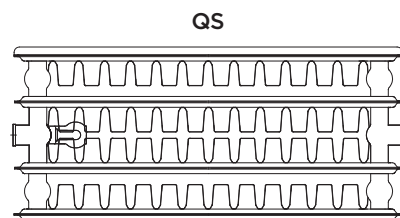

Compact 6 QS radiators do not include rear lugs or brackets and must be floor mounted.

Floor brackets should be purchased separately.

See page 6 for floor bracket compatibility and quantities required.

## Wall Bracket Compatibility

Compact 4 Radiator	Radiator Height	Bracket Code	Quantity x 2 Pcs	Quantity x 3 Pcs
SF / HF DF / DS TS / QS	200mm	2CWB	Radiator Length	Radiator Length
	300mm	3CWB		
	400mm	4CWB		
	500mm	5CWB		
	600mm	6CWB		
	700mm	7CWB		
	900mm	9CWB	400mm to 1600mm	1800mm to 2400mm

## Floor Bracket Compatibility

Bracket Code	SF		HF		DF/DS		TS		QS
	Radiator Height		Radiator Height		Radiator Height		Radiator Height		Radiator Height
	300mm to 400mm	500mm to 900mm	300mm to 400mm	500mm to 900mm	200mm to 400mm	500mm to 900mm	200mm to 400mm	500mm to 900mm	200mm to 300mm
DFBSW					✓	✓	✓	✓	✓
DFBLW					✓	✓	✓	✓	✓
SFBW	✓		✓		✓		✓		
UFBSW		✓		✓		✓		✓	
UFBLW		✓		✓		✓		✓	
Quantity	Radiator Length		Radiator Length		Radiator Length		Radiator Length		Radiator Length
x 2 Pcs	400mm to 1600mm		All Lengths	300mm to 1600mm	All Lengths	300mm to 1600mm	All Lengths	300mm to 1600mm	800mm to 1600mm
x 3 Pcs	1800mm to 3000mm			1800mm to 2400mm		1800mm to 3000mm		1800mm to 2700mm	1800mm to 2400mm

## Concealed Wall Brackets

ALL PRICES EX. VAT

**2CWB**

Concealed Wall Brackets For 200mm High Horizontal Panel Radiators

Nickel N **£2.69** Each**3CWB**

Concealed Wall Brackets For 300mm High Horizontal Panel Radiators

Nickel N **£2.80** Each**4CWB**

Concealed Wall Brackets For 400mm High Horizontal Panel Radiators

Nickel N **£2.96** Each**5CWB**

Concealed Wall Brackets For 500mm High Horizontal Panel Radiators

Nickel N **£3.39** Each**6CWB**

Concealed Wall Brackets For 600mm High Horizontal Panel Radiators

Nickel (Each) N **£3.92** Each**7CWB**

Concealed Wall Brackets For 700mm High Horizontal Panel Radiators

Nickel N **£4.44** Each**9CWB**

Concealed Wall Brackets for 900mm High Horizontal &amp; 1200, 1400, 1600mm Vertical Panel Radiators

Nickel N **£5.29** Each**12CWB**

Concealed Wall Brackets For 1800 - 2000mm High Vertical Panel Radiators

Nickel N **£5.55** Each

## Anti-Lift Brackets

## Floor Brackets

ALL PRICES EX. VAT

**600ALCB2-Z**

For 600mm high radiators.

Nickel N **£38.90** Pair**600ALCB3-Z**

For 600mm high radiators.

Nickel N **£58.40** Set of 3**700ALCB2-Z**

For 700mm high radiators.

Nickel N **£44.10** Pair**700ALCB3-Z**

For 700mm high radiators.

Nickel N **£66.20** Set of 3**SFBW**

Floor Bracket for Single Radiator.

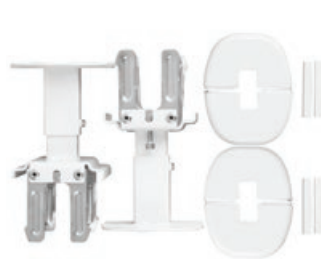
White RAL 9016 W **£37.03** Each**DFBSW**

Floor Bracket for Double Radiator. Short - 120mm to 170mm.

White RAL 9016 W **£36.70** Each**DFBLW**

Floor Bracket for Double Radiator. Long - 240mm to 315mm.

White RAL 9016 W **£61.40** Each**UFBSW**

Universal Floor Bracket. Short - 150mm to 200mm.

White RAL 9016 W **£26.10** Each**UFBLW**

Universal Floor Bracket. Long - 262mm - 360mm.

White RAL 9016 W **£42.40** Each

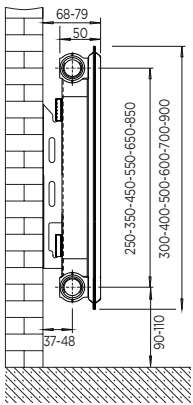

**SF**  
Single Panel  
Single Convactor

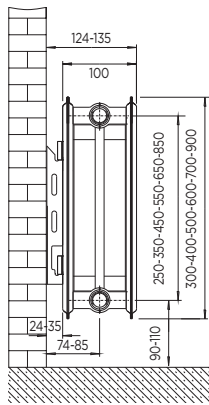

**DF**  
Double Panel  
Double Convactor

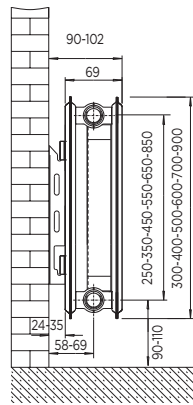

**HF**  
Double Panel  
Single Convactor

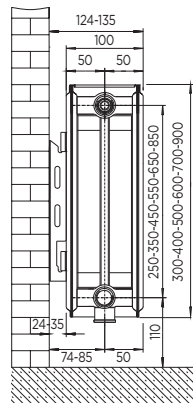

**DS**  
Double Panel  
Double Convactor

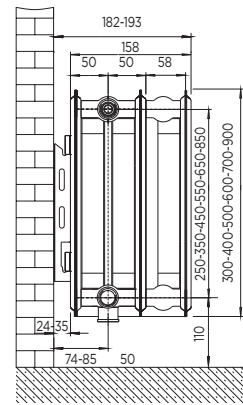

**TS**  
Triple Panel  
Triple Convactor

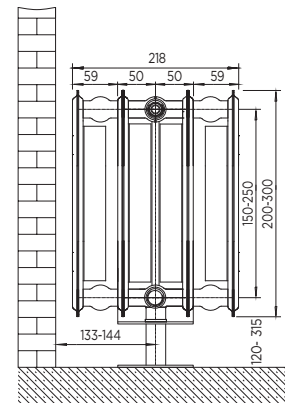

**QS**  
Quadruple Panel  
Quadruple Convactor

**Wall Brackets**

HEIGHT	H	A	B
200mm	75	55	-
300mm	185	155	-
400mm	285	255	90
500mm	385	355	190
600mm	485	455	290
700mm	585	555	390
900mm	785	755	590

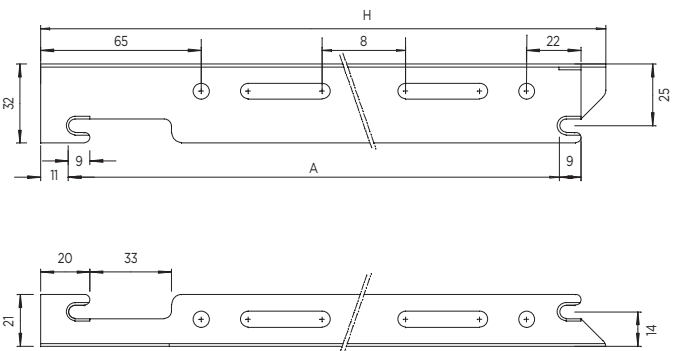
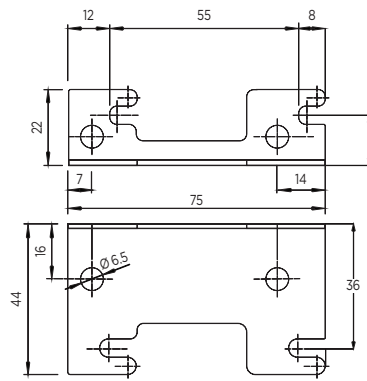

**Bracket Positioning**

LENGTH (mm)	A (mm)		B (mm)		SET OF LUGS
	SF	HF-DF-TS	SF	HF-DF-TS	
400	166	134	117	133	2
500	200	234	150	133	2
600	300	334	150	133	2
700	400	434	150	133	2
800	500	534	150	133	2
900	600	634	150	133	2
1000	700	734	150	133	2
1100	800	834	150	133	2
1200	900	934	150	133	2
1400	1100	1134	150	133	2
1600	1300	1334	150	133	2
1800	767	767	150	133	3
2000	867	867	150	133	3
2200	967	967	150	133	3
2400	1067	1067	150	133	3
2600	1167	1167	150	133	3
2700	1217	1217	150	133	3
2800	1267	1267	150	133	3
3000	1367	1367	150	133	3

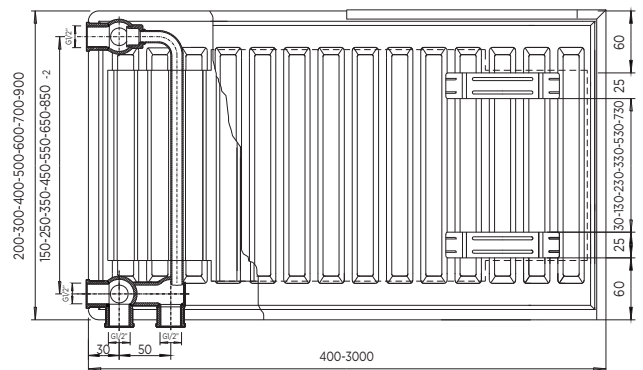
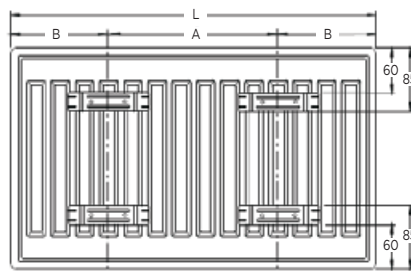

**Water Content and Weight**

per metre length

HEIGHT mm	Inch	SINGLE - SF		SINGLE PLUS - HF		DOUBLE - DF		TRIPLE - TS		QUADRUPLE - QS	
		Litre	Kg	Litre	Kg	Litre	Kg	Litre	Kg	Litre	Kg
200	7.8	-	-	-	-	2.72	10.86	4.05	16.01	5.40	30.15
300	11.8	2.60	8.97	3.50	14.13	3.50	16.05	5.20	23.63	8.10	45.20
400	15.7	2.73	11.65	4.27	18.54	4.27	21.16	6.39	31.33	-	-
500	19.7	2.87	14.33	5.03	22.98	5.03	26.31	7.59	38.99	-	-
600	23.6	3.00	17.01	5.80	27.40	5.80	31.43	8.78	46.59	-	-
700	27.6	3.30	19.39	6.43	31.25	6.43	35.98	9.69	53.84	-	-
900	35.4	3.90	24.87	7.70	42.72	7.70	46.85	11.50	69.74	-	-

DELTA FACTORS IN °C OTHER THAN ΔT50 AT 20°C ROOM TEMPERATURE			
15°C	4.9779	50°C	1.0000
20°C	3.3923	55°C	0.8807
25°C	2.5194	60°C	0.7842
30°C	1.9758	65°C	0.7049
35°C	1.6088	70°C	0.6386
40°C	1.3465	75°C	0.5824
45°C	1.1508	80°C	0.5344

Divide the heat outputs to ΔT50 by respective coefficient above to achieve the corrected heat outputs.



9SF800W



6SF800A



18VSF500W

## INSTALLATION GUIDE

For maximum efficiency, radiators should be fixed at no more or less than the measurements given on the drawings herein, from finished floor level.

We supply a bottom opposite end (BOE) connection pipe positioning guide for the manual valve, please allow 35mm to the centre of the pipe. For TRV valve allow 45mm to pipe centre. To prevent damage, it is strongly recommended that protective packaging is left on the radiator until installation is complete. Simply remove lug protectors and pre-cut tapping connection.

**Finish:** each radiator is degreased and electrostatically powder coated with epoxy polyester stove enamel, after an application of water based primer. Oven baked to provide a high gloss finish in white enamel (RAL 9016) or Anthracite (RAL 7016), the finished surface requires no further painting.

**Water Treatment:** on completion of the installation the system should be properly flushed and filled in accordance with the British Standard Code of Practice for the Treatment of Water in Domestic Hot Water Central Heating System BS7593.



Scan the QR code to receive a digital PDF or to request additional print copies.

## IMPORTANT

Please read the following points carefully before installing your ULTRAHEAT radiator:

- DO** make sure that you have considered the design and layout of your central heating system as this will ensure satisfactory functioning of the system in general, and the radiators in particular.
- DO** vent your system properly. Leak and corrosion problems are usually due to excess air getting into the system.
- DO** ensure that the drain points are at the lowest points in the system.
- DO** make absolutely certain that the system is thoroughly flushed before it is commissioned. Rinse out all metal, flux and other foreign residues; the cause of pin-holing.
- DO** avoid over pumping the system, which causes negative pressure aeration, one of the most common causes of corrosion.
- DO** add an approved chemical inhibitor as an additional safeguard, but remember that it is no substitute for good installation practice.
- DO** observe the above basic guidance. Not only will you protect your warranty, but you will have years of trouble-free service from your radiator.
- DON'T FORGET** – the best radiators deserve the best installation practice.

# ULTRAHEAT

Ultraheat is a heating division of Pitacs Limited

Bradbourne Point, Bradbourne Drive, Tilbrook, Milton Keynes  
Buckinghamshire, MK7 8AT, United Kingdom

T: +44 (0)1908 271155 F: +44 (0)1908 640017  
E: heating-sales@pitacs.com W: www.ultraheat.co.uk



5 056498 332043 >

PL-ULTRAHEAT-C4-GBP-JUL24